

# INSTALLATION INSTRUCTIONS

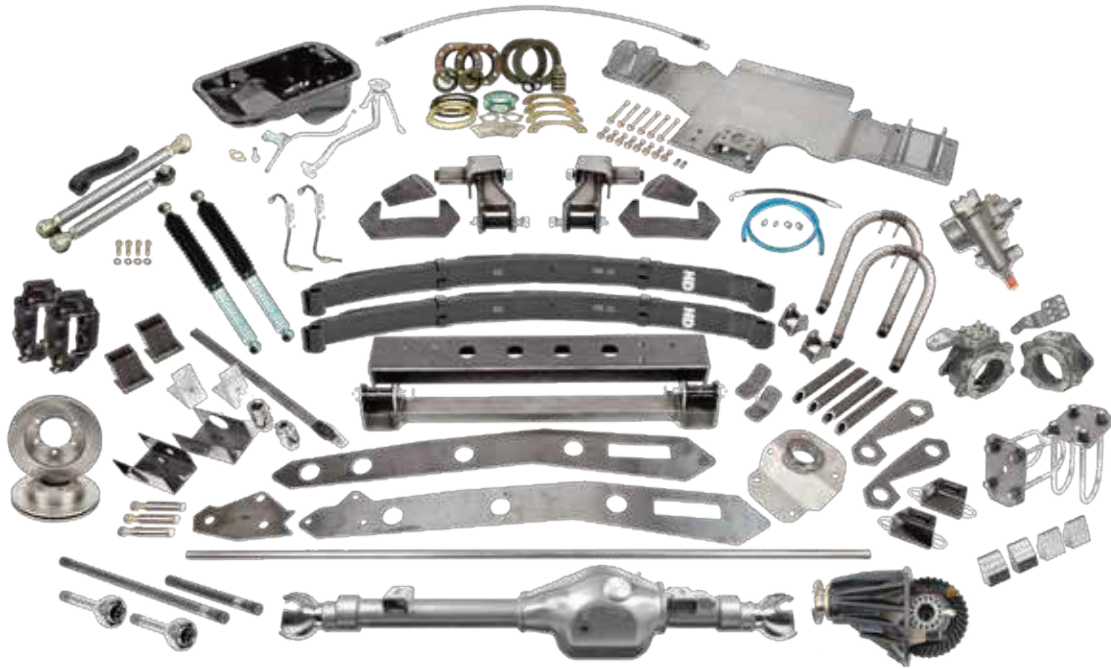

## 1995 - 2004 TACOMA SAS KIT A, B, & C KIT CONTENTS

Kit C shown below. Your kit contents may vary.



### NOTE

This build is so in-depth that not every step could be covered in these instructions. If anything is not clear, please call our tech support line at 1.877.4X4.TOYS before proceeding. We have trained technicians waiting to help you.

	<b>CAUTION</b>
	Flying Object Hazard. Wear safety glasses at all times when working on vehicle.

305921-1-INS

## RECOMMENDED TOOLS

		<b>Sockets</b>	<b>Wrenches</b>
Loctite	Level		
Cutoff Wheel	Straight Edge	8mm	8mm
Welder	Punch	10mm	10mm
Grinder	C-Clamps (2)	12mm	12mm
Plasma Cutter	Gasket Scraper	13mm	13mm
Paint Pen	Drill	14mm	14mm
Tape Measure	5/16" Drill Bit (2.4 Engines Only)	17mm	17mm
Jack Stands	Allen Set	18mm	18mm
Floor Jack	Flathead Screwdriver	19mm	19mm
3/8" Ratchet	Pliers	21mm	21mm
1/2" Drive Ratchet	12" Extension	3/8" Drive 17mm	3/4"
Hammer	2 Qts Power Steering Fluid		15/16"

## CAUTION

1. Read all instructions completely and carefully before you begin.
2. Check to make sure the kit is complete and that no parts are missing (refer to the Kit Contents List on the first page of these instructions). If anything is missing, please contact Trail-Gear at 559.252.4950.
3. Park vehicle on a clean, dry, flat, level surface and block the tires so the vehicle can not roll in either direction.
4. This product is for off-road use only. It is recommended that the installation steps below be performed by a competent mechanic. Buyers and users of this product hereby expressly assume all risks associated with the installation and use of this product.



# INSTALLATION INSTRUCTIONS



## STEP 1

Remove front bumper, skid plate, and splash guards.



## STEP 2

On vehicles with a 3.4L V6 engine that have a radiator that hangs below the frame like shown, you will need to replace the radiator with the following part numbers. (Performance Radiator #1774, Napa # APD 2740)



## STEP 3

Mark the edge of the radiator for future use.

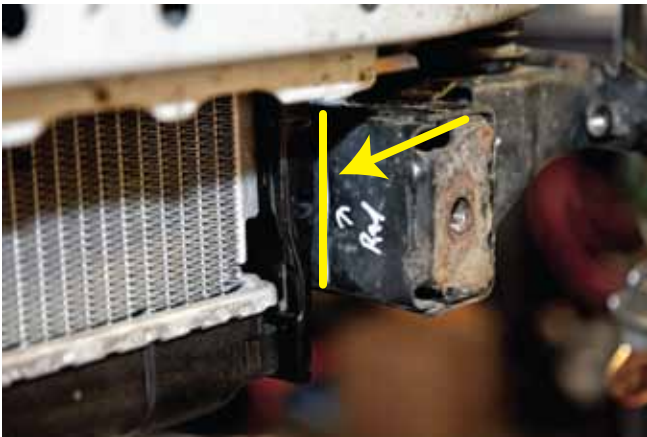

## STEP 4

Remove the radiator.



## STEP 5

Unbolt and remove all IFS components.



## STEP 6

Mark the body mount as close to the weld as possible.





# INSTALLATION INSTRUCTIONS



## STEP 7

Cut the body mount along the previously drawn line and grind the weld down. You want an approximately 1/4" gap between the frame and the edge of the mounting bracket when finished.



## STEP 8

Cut the inner support plate of the body mount 1/2 of the way in.



## STEP 9

Slide front hanger mount onto the frame rails. Mount hanger locating jig to the body mount and slide it all the way forward.



## STEP 10

Use a straight edge to ensure that the mount is flush with the jig.



## STEP 11

Make sure the mount is square and straight to the truck.



## STEP 12

Tack the mount in place. Verify the mount is still straight and weld it completely.





# INSTALLATION INSTRUCTIONS



## STEP 13

Weld the area shown below.



## STEP 14

Weld the areas shown below.



## STEP 15 A

Install spring hanger gussets in location shown



## STEP 15 B

Remove paint, and prep for welding



## STEP 15 C

Completely weld part as shown. Repeat on opposite side.



## STEP 16

Cut the brake line tab off as shown for future use.



# INSTALLATION INSTRUCTIONS



## STEP 17

After all of the other brackets have been unbolted or removed, brackets 1, 2, 3, and 4 will need to be removed with a torch or plasma cutter.

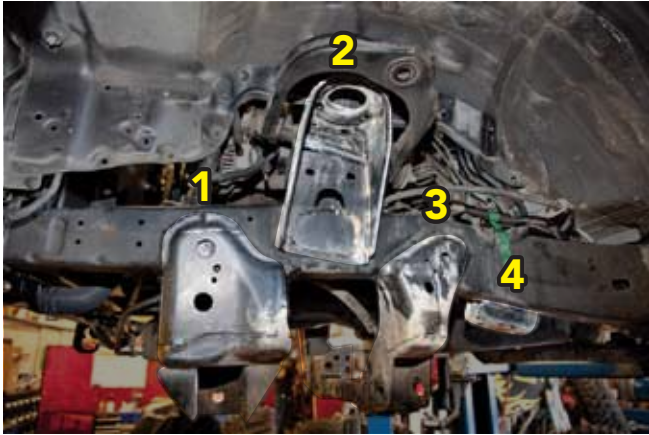

## STEP 18

Grind the frame clean.



## STEP 19

If you have a 2.7L engine, start here to remove the oil pan. If you have a 3.4L engine, skip to step 36. Remove the dust shield.



## STEP 20

Remove the oil pan.



## STEP 21

Remove dipstick bracket hardware.



## STEP 22

Remove the stock dipstick.





# INSTALLATION INSTRUCTIONS



## STEP 23

Apply Ultra Grey to bottom of freeze plug.



## STEP 24

Place freeze plug in stock dipstick hole.



## STEP 25

Lightly tap freeze plug to secure it into place.



## STEP 26

Locate the small freeze plug approximately 2" behind motor mount.



## STEP 27

Using a punch, remove the freeze plug.



## STEP 28

Install the new dipstick tube into the block using ultra grey at the mating surface.

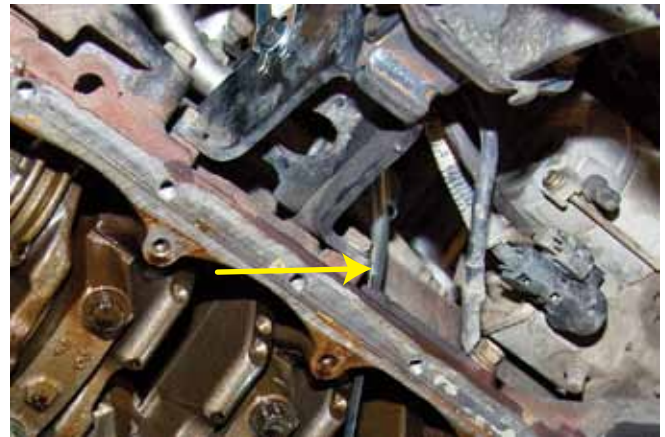



# INSTALLATION INSTRUCTIONS



## STEP 29

Mark and drill a hole in the motor mount bracket to mount the dipstick tube. We drilled a 5/16" hole and used an 8mm bolt.



## STEP 30

Fasten the dipstick tube to the motor mount.



## STEP 31

Remove the stock strainer and install the new one.



## STEP 32

Using a razor, clean the oil pan mating surface on the block.



## STEP 33

Apply a bead of ultra grey to the oil pan mating surface.



## STEP 34

Install the new oil pan. The strainer now sits towards the back of the truck.





# INSTALLATION INSTRUCTIONS



## STEP 35

Re-install the dust shield.



## STEP 36

Install the drain plug with gasket.



## STEP 37

If you have a 3.4L engine, follow these instructions to replace your oil pan. Remove dust shield.



## STEP 38

Remove the oil pan.



## STEP 39

Remove the stock strainer and replace it with the new one.



## STEP 40

Using a razor, clean the oil pan mating surface on the block.



# INSTALLATION INSTRUCTIONS



## STEP 41

Mark the stock dipstick 1/8" below the full line and cut off the excess. The stock full level on the dipstick will still be used and 6 1/2 quarts of oil are used.



## STEP 42

Re-install the dip stick into the block.

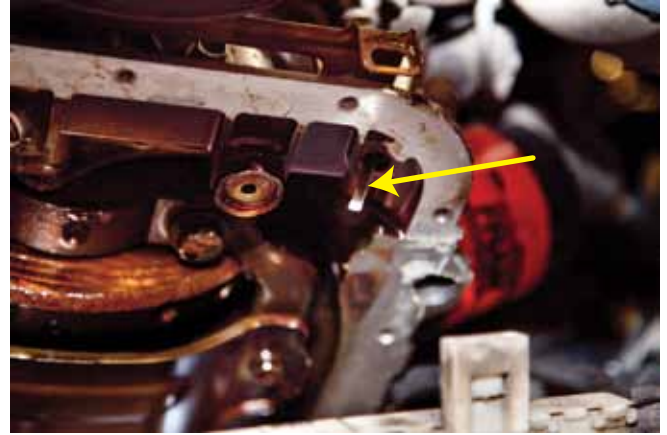

## STEP 43

Apply a bead of ultra grey to the oil pan mating surface.



## STEP 44

Install the new oil pan. The strainer now sits towards the back of the truck.



## STEP 45

Re-install the dust shield. The circled bolt will need to be shortened by 3/8"



## STEP 46

Install the drain plug with gasket.





# INSTALLATION INSTRUCTIONS



## STEP 47

Weld off the body mount.



## STEP 48

If you have a 3.4L motor, remove the O<sup>2</sup> sensor above resonator and follow step 48, otherwise, skip to step 49.



## STEP 49

Remove the resonator to give yourself room to cut out the frame rail for the shackle mount.



## STEP 50

The body mount modification is located under the floorboard for the shackle mount. Mark 2 1/4" up from the bottom of the front side of the body mount bracket. Mark 2 1/2" from the outside of the body mount towards the centered of the body mount. Follow factory edge and draw lines as shown.



## STEP 51

Cut along the lines and remove the bracket as shown. Grind the frame clean.



## STEP 52

Measure from the inside of the face of the front hanger mount 45 7/8" and mark the frame. The mark should be in the center of the big hole in the template. Align the frame jig as shown with the large hole facing the outside of the vehicle. Make sure the rear of the jig is in contact with the frame. Tack weld it in place.





# INSTALLATION INSTRUCTIONS



## STEP 53

A small gap between the frame and the front of the jig is normal due to frame curvature.



## STEP 54

Mark the frame through the holes in the bottom of the jig.



## STEP 55

Outline the jig on the inside of the frame as shown.



## STEP 56

Cut the larger hole on the outside of the frame with the jig in place with a hole saw or plasma cutter and then remove the jig.



## STEP 57

Use a straight edge to connect the lines made with the jig like the image below.



## STEP 58

Cut the frame with a plasma cutter along the inside of the line, clean slag off of the frame.





# INSTALLATION INSTRUCTIONS



## STEP 59

Cut the internal frame support to be flush with the previous cut and grind clean.



## STEP 60

Remove the brake line clip from the frame on the driver's side above the shackle location.



## STEP 61

Install shackles into the shackle mount and clamp into frame with alignment bar installed to make sure the shackles are square. Make sure the shackles are 29" center to center. Note: Manual transmissions can run the alignment tube through shackle box mount.



## STEP 62

Below is an example of incorrect fitment. Notice the mount sticking out below the frame.



## STEP 63

Below is the correct fitment of the mount. Notice how the bottom of the mount is even and almost flush against the bottom of the frame.

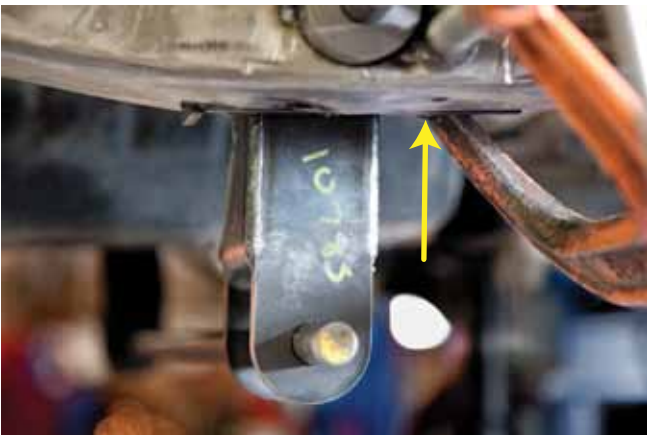

## STEP 64

Below is an example of incorrect fitment. The shackles need to be parallel.



# INSTALLATION INSTRUCTIONS



## STEP 65

Below is the correct fitment of the shackles. Notice how they are parallel.

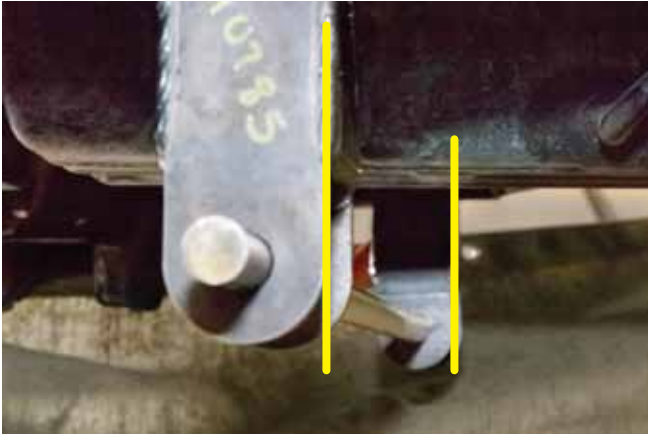

## STEP 66

Once the shackles are straight and at the correct distance apart (29" center of shackle to center of shackle), tack weld the tube into the frame.



## STEP 67

Once the shackle mount is tacked into the frame, clamp the support plate to the frame and tack it into place.



## STEP 68

Weld the support plate to the frame.



## STEP 69

Remove poly bushing and weld the shackle tube to the frame.



## STEP 70

Install the shackle mount boxing bracket on top of the shackle mount and weld it into place.





# INSTALLATION INSTRUCTIONS



## STEP 71

Weld the shackle mount to the bottom of the frame.



## STEP 72

Grind the weld smooth.



## STEP 73

Place the bottom frame support bracket on the bottom of the frame and tack the rear portion to the frame.



## STEP 74

Clamp the front portion of the support to the frame to form it to the frame curve and tack it into place.



## STEP 75

Finish welding the bottom support plate.



## STEP 76

For 3" springs we recommend starting off with the front hanger 44 1/2" from the shackle bolt center to bolt center and move it approximately 3/8" forward for 4" springs and 3/4" forward for 5" springs. Note, these are only recommendations to verify location.





# INSTALLATION INSTRUCTIONS



## STEP 77

Tack weld the spring hanger into place, centering it upon the mount.



## STEP 78

Install springs and axle. Place the weight of the vehicle on the springs to ensure proper shackle angle is achieved. We recommend a 90° shackle angle during initial setup to allow for spring break-in. If so, move to step XXX, if not, take the weight of of the springs and move the hanger to achieve desired shackle angle. Once correct, move to step XXX.

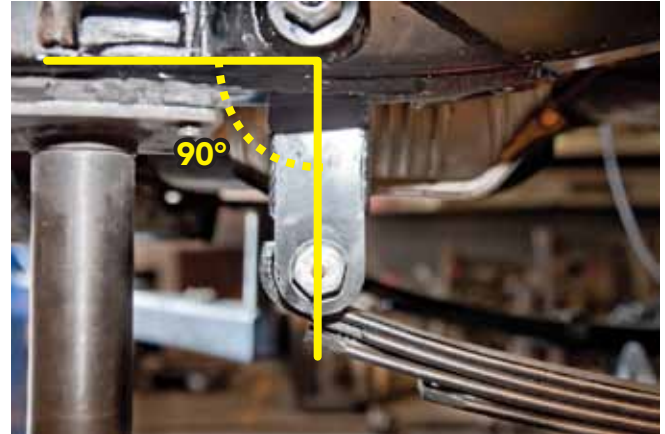

## STEP 79

With weight still on springs, clamp the steering box in desired location and mark the front hole.



## STEP 80

Make sure the tie rod and drag link will not make contact when the vehicle flexes.



## STEP 81

Clamp the frame plate to the frame, centering it on the frame and aligning it with the previously marked hole.



## STEP 82

Using the frame plate as a template. Drill the 2 marked holes in the frame to 1/2". Be sure to drill straight through both sides of the frame.





# INSTALLATION INSTRUCTIONS



## STEP 83

On the inside of the frame only, drill holes to 3/4" to allow the sleeves to be installed in the frame.



## STEP 84

Install (3) 1/2" bolts through the previously drilled holes. Install sleeves over bolts and inner frame plate as shown.



## STEP 85

Tack weld the inner frame plate and sleeves in place.



## STEP 86

Tack weld the frame plate to the frame and then weld in sections to avoid frame warping. At this time you can also weld off inner frame plate and sleeves.



## STEP 87

On the passenger side, position and clamp the frame plates to the frame, aligning the rectangle hole and centering the rest of the plate on the frame.



## STEP 88

You may want to plug weld the frame holes shown.

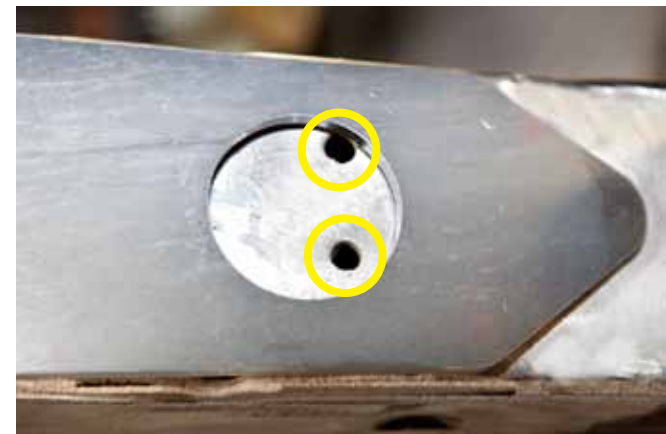

# INSTALLATION INSTRUCTIONS



## STEP 89

Tack weld the frame plate to the frame and remove the clamps.



## STEP 90

We recommend welding the frame plate onto the frame in steps, allowing the frame to cool to prevent warping. First, weld the frame plate inner holes.



## STEP 91

Next, weld the front and rear and the angled section of the frame plate to the frame.



## STEP 92

Finish welding the frame plate to the frame.



## STEP 93

Mark the inner fender well as shown in the picture below. Be careful not to cut out the pinch weld.

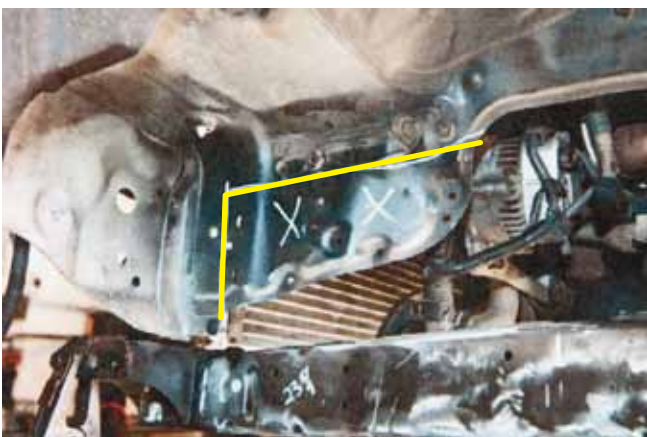

## STEP 94

Cut the inner fender well along the previously marked cut lines.

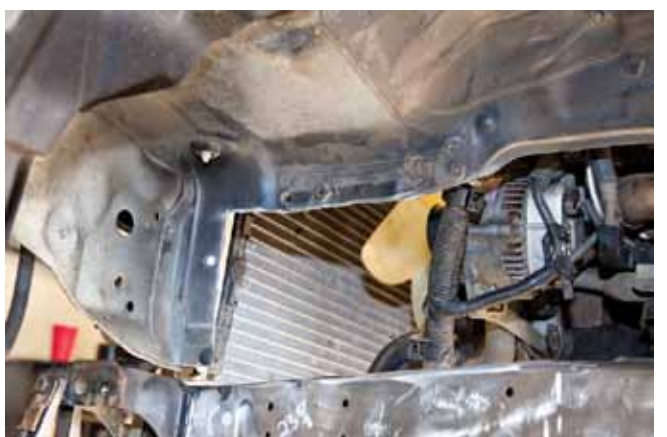



# INSTALLATION INSTRUCTIONS



## STEP 95

Set the vehicle on jack stands and install shock hoops and shocks. At ride height, shock should be centered in shock hoop and perpendicular to the floor, not slanted forwards or backwards.



## STEP 96 CONTINUED



## STEP 97

Install shock hoop support tubes.



## STEP 98

During full extension of the suspension it is normal for the shock to angle forward slightly because the shackle allows the axle to swing forward.

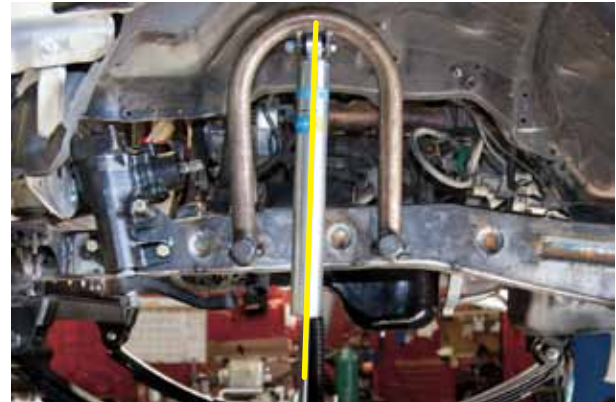

## STEP 99

Weld previously cut brake line tab to frame as shown.

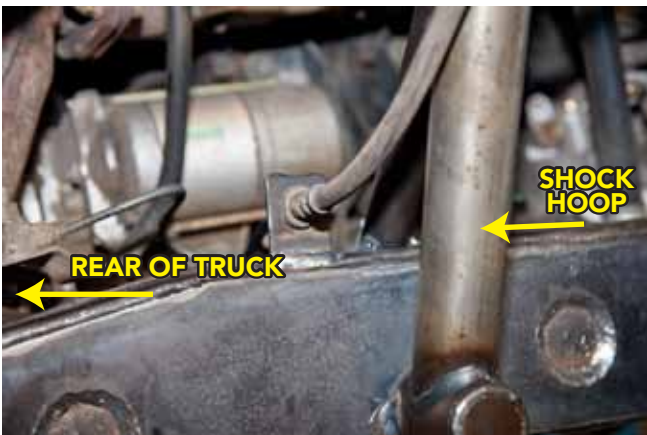

## STEP 100

Tack weld the body mount gussets into place.



# INSTALLATION INSTRUCTIONS



## STEP 100

Fully weld the body mount gussets to the frame and body mount bracket.



## STEP 101

Flex the truck until the springs are nearly flat in the front passenger corner. Place the bump stop extension against the frame. Center it with the bump stop and mark the frame and extension. Some trimming of the bumpstop extension may be required.



## STEP 102

Weld the bump stop extension to the frame.



## STEP 103

At this point, all welding should be completed. You can now paint the frame and raw metal parts as desired.



## STEP 104

Install the IFS steering box.



## STEP 105

Remove the steering shaft dust cover located behind the brake pedal.





# INSTALLATION INSTRUCTIONS



## STEP 106

Remove the steering shaft and coupler from the column.



## STEP 107

Remove the seal housing from the firewall.



## STEP 108

Remove the seal from the seal housing.



## STEP 109

Install the factory seal from your seal housing into the supplied seal housing. Paint the housing.



## STEP 110

Install the seal housing into the firewall.



## STEP 111

Install the supplied steering box coupler to the supplied steering shaft. Tighten long set screw to make a mark on shaft. Remove the coupler.



# INSTALLATION INSTRUCTIONS



## STEP 112

Using the previously made mark, drill one side of the shaft out to 3/8".



## STEP 113

Once the hole is drilled, install the coupler using red loctite on the set screws.



## STEP 114

Loosen the set screw to allow for adjustment.



## STEP 115

Slide the steering shaft through the seal housing and install to the new coupler and column as shown. Make sure to use red loctite on all set screws.



## STEP 115 CONTINUED

Note: 95.5 Tacoma steering shafts are a different spline and size than 96-04. Because of this, when installing the steering joint in a 95.5, you will get a 9/16" x 3/4" double-d steering joint. The 9/16" end will have no splines, this is the side of the steering joint that you will put over the splined section of your steering rod.

Use the set screw to make the same type of mark you did on the first end, then drill out the hole. Install the joint and tighten the set screw, we recommend putting a small tack weld on each side of the joint as a safety precaution.

## STEP 116

Install coupler to steering box using red loctite on set screw.





# INSTALLATION INSTRUCTIONS



## STEP 117

Remove the half moon piece from your original fan shroud and reuse it on the new fan shroud.



## STEP 118

The lower fan shroud tab on the driver's side might need to be trimmed to clear the steering box.



## STEP 119

A self tapping screw may also be required to secure the fan shroud to the radiator. Be careful not to drill through the radiator.



## STEP 120

Slight notching of the fan shroud may be necessary to clear the steering box mount.



## STEP 121

The new radiator should be approximately 2" shorter than the original radiator.



## STEP 122

By this point you should have your Rock Assault™ or OEM Toyota axle housing all painted and ready to install six stud knuckles and brake components.





# INSTALLATION INSTRUCTIONS



## STEP 123

This is how your axle will look with the six stud knuckles, spindle, and birfield installed.



## STEP 124

Rock Assault™ axle housing with vented rotor and V6 caliper installed.



## STEP 125

Attach leaf springs to axle with provided u-bolts. Center the leaf spring center pin over the centering hole on the spring perch and install u-bolt flip kit as shown in the picture. Tighten by hand until snug. Retighten after initial test drive.



## STEP 126

Install provided hard caliper line and extended brake line and hand tighten. Assembly should look similar to the picture below when completed.

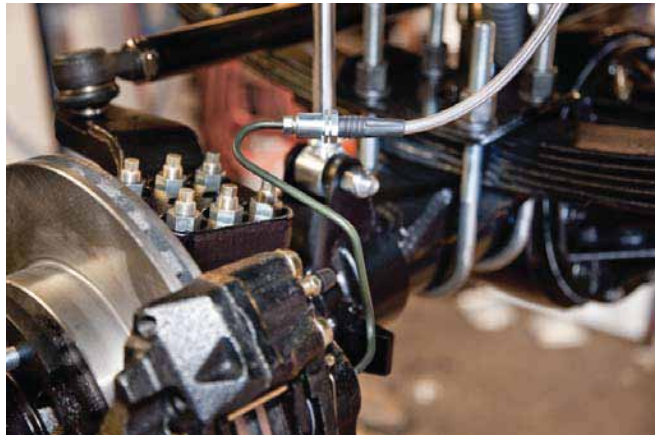

## STEP 127

Install lower shock mount.



## STEP 128

Finish welding shock mount and tighten shock mount bolt. Assembled product should look similar to the image below.





# INSTALLATION INSTRUCTIONS



## STEP 129

Place the steering wheel so that it is in the center of its movement left to right. Bolt on the pitman arm using the stock nut and washer. Connect the left side of the steering Drag Link to the front most hole in the right side steering arm. Tie rod ends should have approximately 3 exposed threads. Do not expose more than 1/2 of the tie rod end threads as this can cause an unsafe driving condition.

With the truck on the ground, set the tow-in of the front tires at 1/8". This is done by turning the Tie Rod with the jam nuts loose. Measure the widest part of the tire at the front and rear of the tire. Adjust the Tie Rod until the front is 1/8" narrower than the rear.

Once completed, turn the steering wheel all the way left and right. Verify that the wheels turn the same amount left and right. If not, adjust the length of the drag link or adjust the position of the pitman arm.

Tighten the pitman nut to 130 ft/lbs. Tighten the jam nuts on the Tie Rod and Drag Link using an adjustable wrench.

## STEP 129 CONTINUED



## STEP 129 CONTINUED



## STEP 130

Now you are ready to install your power steering hose conversion kit. If you have a 2.7L, see steps 130-141. If you have a 3.4L, see steps 142-147.



## STEP 131

Remove the OEM rack and pinion unit from the truck.

## STEP 133

Remove the return line that ran from the rack and pinion to the power steering cooler.

## STEP 135

After installing your IFS gear box, you will want to route, measure, and cut a piece of the blue low pressure return line from the IFS box to the factory power steering cooler.

## STEP 132

Remove the high pressure hose that ran from the power steering pump to the rack and pinion.

## STEP 134

Remove the return line that runs from the power steering cooler to the power steering reservoir.

Now that everything has been removed you are now ready to install your new IFS power steering box and your hoses. See IFS box installation instructions for IFS box installation.

# INSTALLATION INSTRUCTIONS



## STEP 136

Next you will take your remaining length of low pressure return line and run it from the power steering cooler to the power steering reservoir.



## STEP 137

Included in the kit is a "banjo eliminator" fitting, install that into the outlet port of your power steering pump.



## STEP 138

Install your provided high pressure line from the banjo eliminator fitting to the newly installed IFS box.



## STEP 139

Make sure all lines are tight and secure, fill with power steering fluid.

## STEP 140

Start motor and began bleeding the power steering system while checking for leaks.

## STEP 141

The system is bled and no leaks were found, you are ready for a test drive.

## STEP 142

After test drive check again for leaks.

## STEP 143

Remove factory high pressure and low pressure lines from the pump and reservoir.



## STEP 144

Install supplied high pressure fitting into pump and low pressure line onto reservoir.





# INSTALLATION INSTRUCTIONS



## STEP 145

Tighten hose clamp on low pressure line. Install high pressure line and tighten.

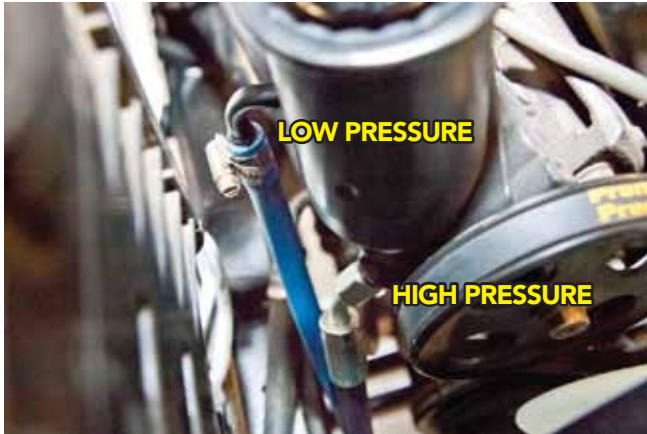

## STEP 146

Route hoses and show being sure to keep away from moving parts.



## STEP 147

Install hoses to steering box as shown and tighten.

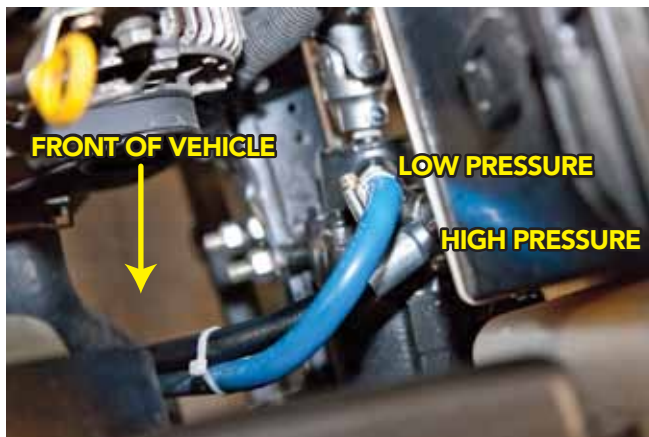

## STEP 148

Fill system with fluid. Bleed steering system. Top off fluid, start engine, and finish bleeding. Once complete, top off fluid and test drive.

## STEP 149

Before installing your driveline to your newly attached axle housing, you will need to install the provided t-case crossmember.

## STEP 150

After crossmember is installed, you will want to install your front driveline. Front or rear driveline may need to be lengthened or shortened depending on whether single or dual cases were installed and the size of the lift that was installed.

## STEP 151

After putting the tires on the axle, please inspect everything to ensure that all welds are complete, all bolts are tightened, all fluids are refilled, and the truck is ready for a test drive.

## STEP 152

After test drive, please check all bolts for tightness, check all welds, check for leaks, and enjoy.